

AM26B-24D

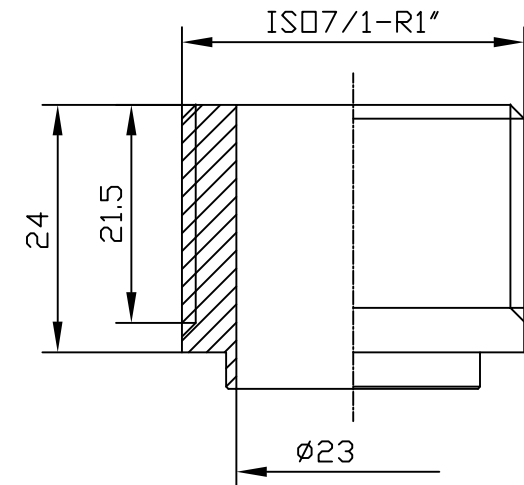

Chiller Manufacturer • HVAC & R Expert • Process Cooling Specialist

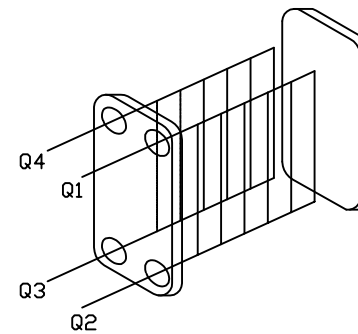
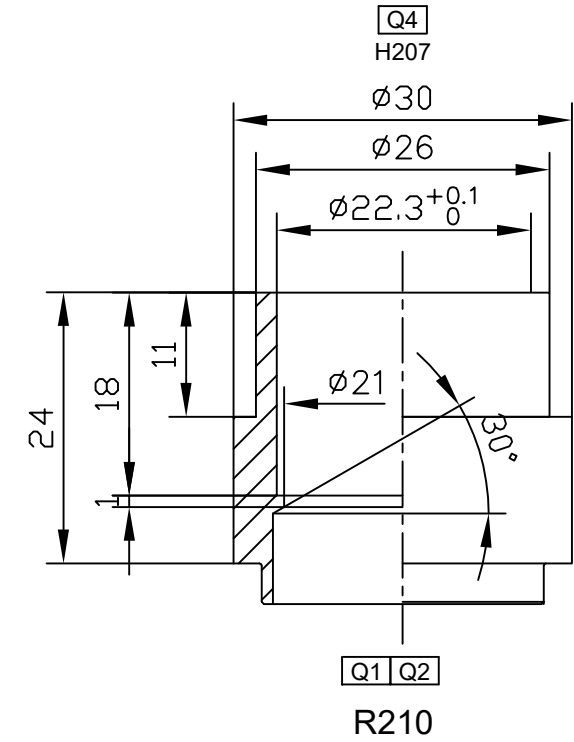
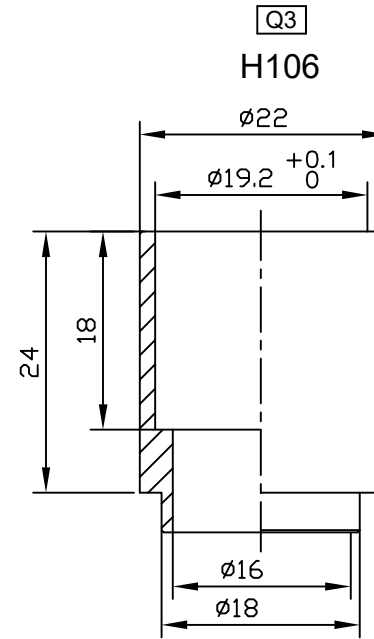
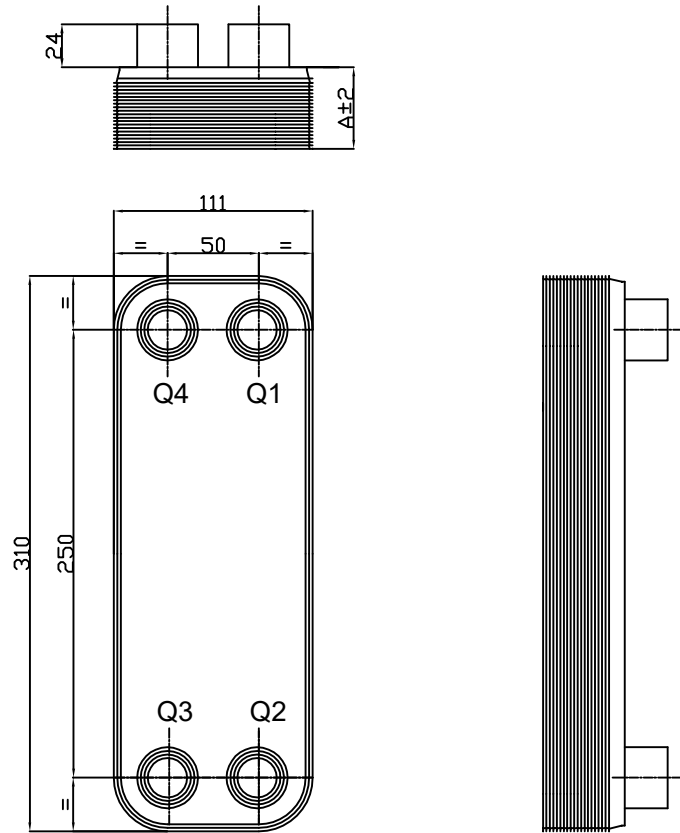

Number of Plates	24D	
Plate Thk (A)	67	
Design Pressure (MPa)	3.0	
Testing Pressure (MPa)	4.5	
Working Temp (°C)	-160~+200	
Q1	R1"	
Q2	R1"	
Q3	19.2	
Q4	22.3	
H1		
H2		
H3		
H4		

MODEL : AM26B-24D-3.0 (H106-Q3,H207-Q4,R210-Q1-Q2)